

Little Monogrammed Purse

Lezette Thomason, Children's Corner
Just for **BERNINA!**

BERNINA 

A monogrammed purse is the perfect accessory for a little girl's necessities. This free project is easy to make and teaches cute techniques and several machine feet.. It is about 6" long, 4" wide and 5" tall. Piece dimensions include 1/4" seams.

Supply list for purse:

1/4 yard each of two companion fabrics.

1/8 yd. of a solid color fabric

1/4 yard medium weight fusible stabilizer

Instructions for cutting purse:

1. Cut out all fabric pieces using enclosed pattern except for one of the sold pieces to be monogrammed. Trace around this piece on solid fabric. Follow directions on pattern piece for cutting.
2. Cut a piece of fusible stabilizer for each piece including lining that is 1/4" smaller all around than fabric pieces.
3. Fuse stabilizer pieces to wrong side of fabric pieces.
4. Rotary cut a crosswise strip of companion fabric (lining fabric) for ruffle 18" long and 1 1/4" wide.



Instructions for constructing purse

1. Monogram sold piece. Then cut out.
2. Hem one long of the ruffle using a rolled hemmer.
3. Stitch a line of lengthened machine stitching (stitch length about 3.5) down other long end, stitching 1/8" from raw edge. Use the #13 foot
4. Stitch another line of lengthened machine stitching 1/4" from the first stitching. Use the #37 foot.
5. Pull up bobbin thread until ruffle fits outside curve of monogrammed piece. With right sides together pin ruffle to outside edge of monogrammed piece distributing gathers evenly. Stitch ruffle in place.
6. With right sides together stitch flap lining to flap, stitching on top of previous stitching. Trim seam to 1/8" and overcast.
7. With right sides together stitch side seams of purse body. With right sides together stitch side seams of purse lining body, leaving a 4" opening on one side seam. Press seams open.
8. Mark the center of ends and sides on oval bottom and bottom lining. Mark the center of the front and back purse body and purse body lining.
9. With right sides together pin purse body to oval bottom, matching side seams to centers of ends and center front and center back of purse body to side centers on oval bottom. Stitch oval bottom to purse body. Do the same to lining.

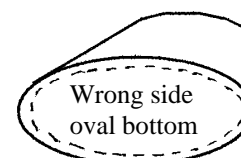
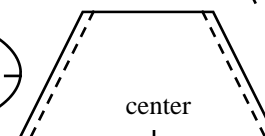
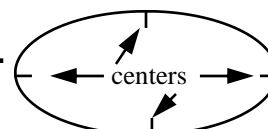
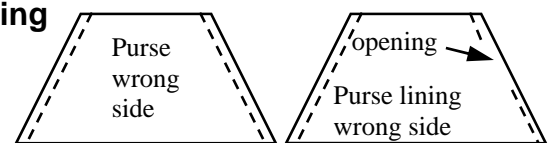
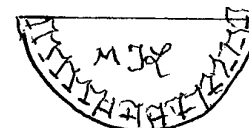
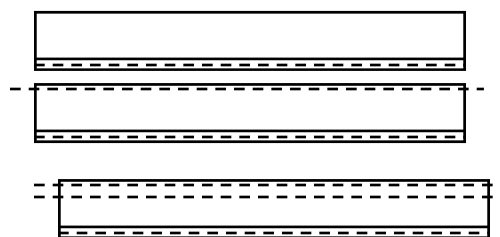

10. Decide which side of purse body will be the back. With right sides together stitch the monogrammed flap at top of purse body back.

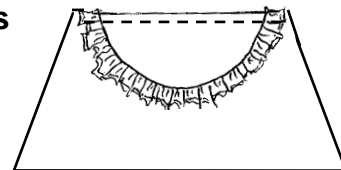

11. Strap: Cut a crosswise strip of fabric from each of three colors that is 36" long and 1 1/8" wide. Fold with right sides together and stitch long side using a 1/8" seam and a #13 foot. Turn tubes to right side.

12. Stack tubes and stitch across ends. Place under sewing machine foot at stitching with needle down. Braid the entire 36". When braid is finished stitch across tubes at other end to hold in place.

13. Pin braid on either side of purse body at top side seam and stay stitch in place.

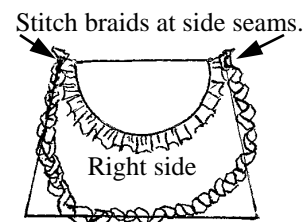

14. Place purse inside of purse lining with right sides together. Push both monogrammed flap and strap inside out of the way. Stitch together around top. Trim and overcast with #2 foot. Turn to right side through the opening left in lining side seam. Stitch opening closed.

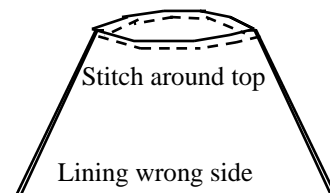

15. Push lining down into the purse

16. Press well. A sleeve board is recommended for pressing small creations.

©Copyright 2010
LezetteThomason

www.childrenscornerinc.com

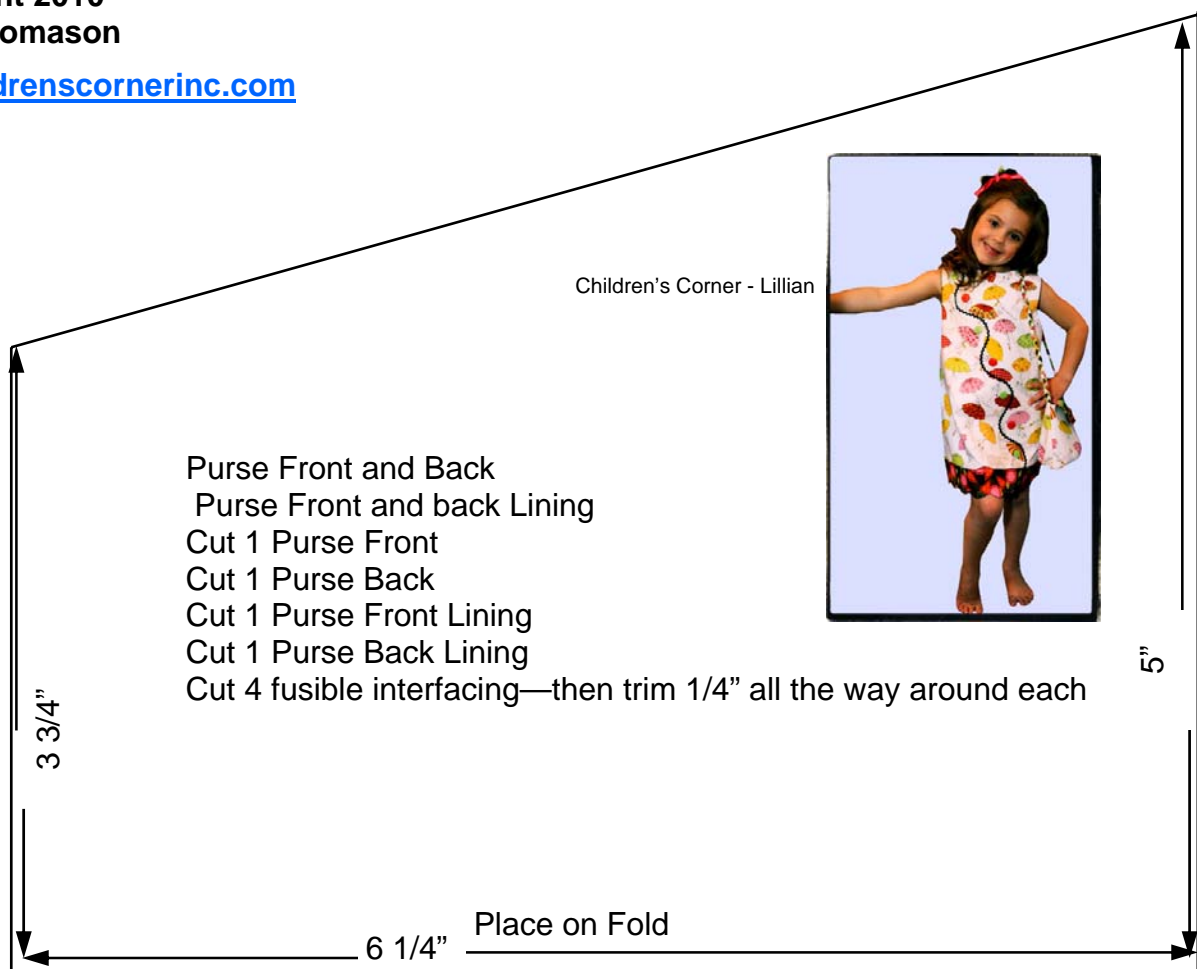

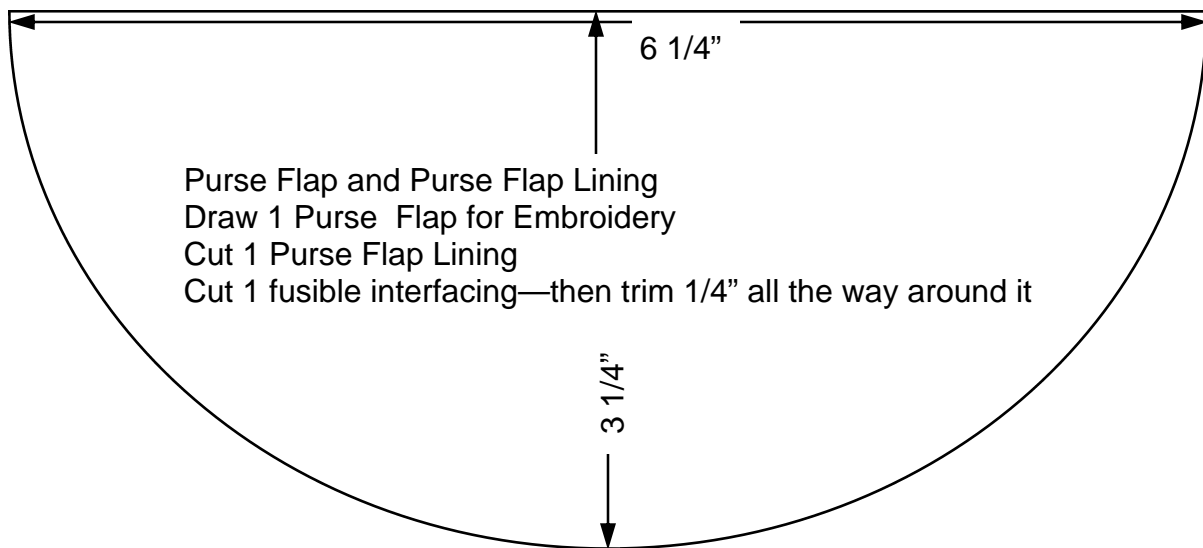
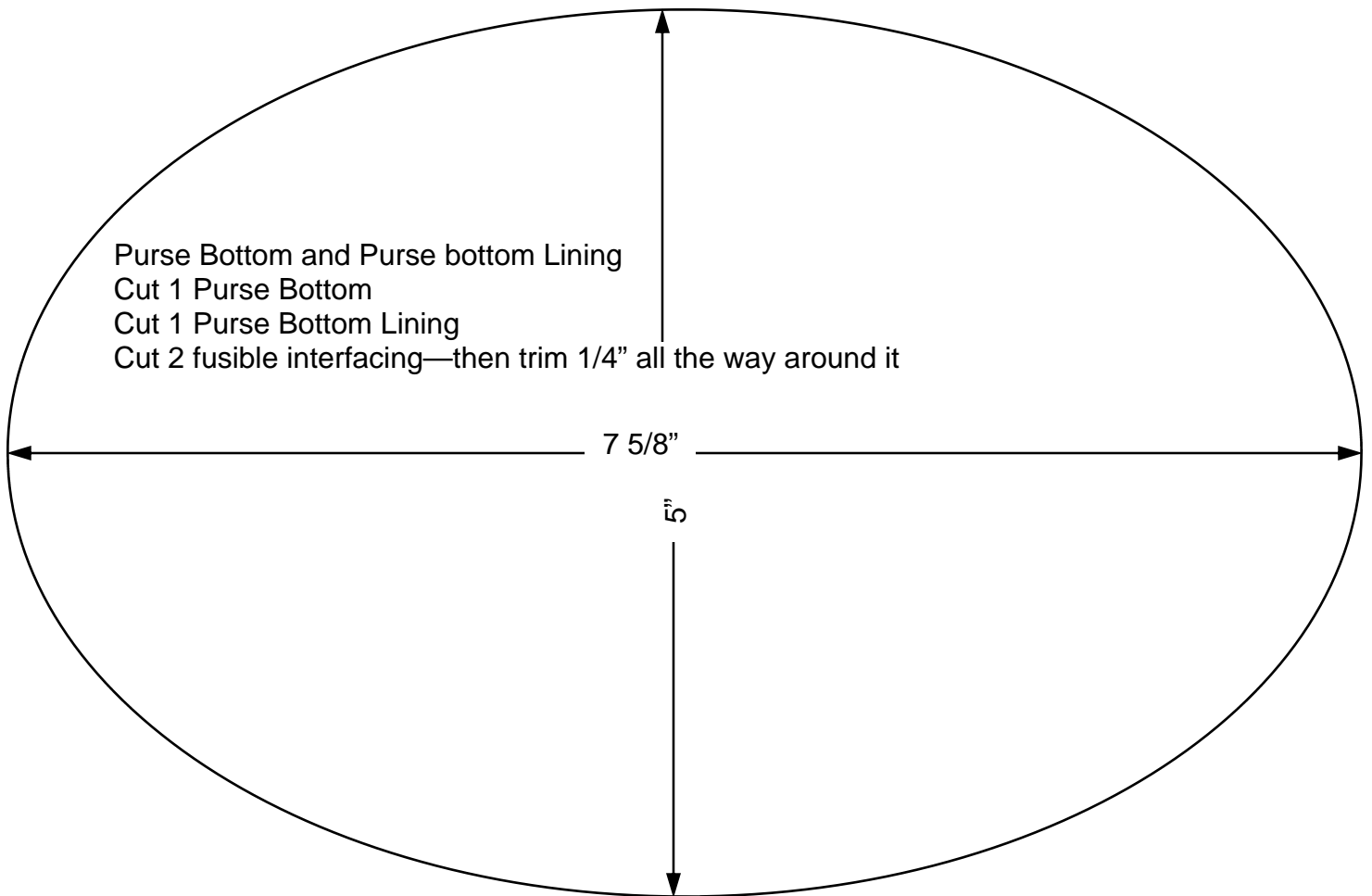

Cut ruffle from lining fabric 18" long and 1 1/4" wide on crosswise of fabric.

This is a great pattern for an evening purse made with fancy fabrics and embellished on your **BERNINA**.

You can also enlarge it on your copier if you desire a bit larger purse. Then let your **BERNINA** express your imagination.